

SU Series – Part Numbering



Features

- Safe connection / Easy mounting
- Antenna Interface Standards Group(AIGS) specification
- Electro Magnetic Protection
- Protection rating of IP67
- Compatible according to IEC 60130-9

Applications

- Electronic Precision Equipment
- Control Engineering
- Automation
- Medical

Part Numbering

Series	Size	Body Type	No. of Contact	Contact Type	Option	Notes	Page
					PCB		
SU	20	SP	8	P		Plug	62
		P		S		Plug	62
		SBR		S	●	Receptacle	62
		BR		P	●	Receptacle	62
		BRC				Receptacle cap	63
		SBRC				Receptacle cap	63

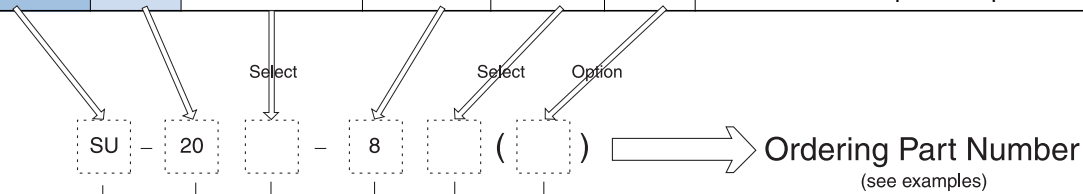

Connector Series

SU20 Series

Body Type

SP : Plug
P : Plug
SBR : Receptacle
BR : Receptacle
SBRC : Receptacle cap (accessory)
BRC : Receptacle cap (accessory)

No. of Contact

8

Contact Type

P : Pin
S : Socket
none : Receptacle cap

Option (for receptacle)

PCB : PCB contact termination

Examples

SU - 20SP - 8P

SU series - Size 20 Plug - 8 contacts pin

SU - 20P - 8S

SU series - Size 20 Plug - 8 contacts socket

SU - 20SBR - 8S

SU series - Size 20 Receptacle - 8 contacts socket

SU - 20BR - 8P (PCB)

SU series - Size 20 Receptacle - 8 contacts pin (PCB termination)

Specifications subject to change without notice. Consult Sam Woo Electronics for the latest specifications.

Major Performances / Contact Arrangements

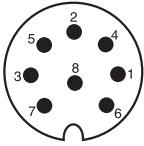
Performance	Size / No of Pin	Size 20
		8
Withstanding Voltage (per min) ¹		AC 1000V
Rated Current		5A
Rated Voltage		60V AC
Insulation Resistance (Minimum) ²		1,000MΩ
Contact Resistance (Maximum) ³		≤5mΩ
Solder Pot Inside Diameter		∅0.8
IP Protection Rating		IP 67
Contact Arrangement		

- ¹ Withstanding voltage is the tested voltage value in this table.
- ² Insulation resistance is measured at DC 100V.
- ³ Contact resistance is measured at DC 1A.
- Values are from tested items and may not apply to all connectors.
- Specifications subject to change without notice.
- Consult Sam Woo Electronics for the latest specifications.

Material Used / Finishing Material

	Material	Finish
Body	ZnDC, Brass	Sn, Ni plate
Insulator	PA	Black
Contacts	Pin	Brass
	Socket	Phosphor bronze

SU Series Mini-map

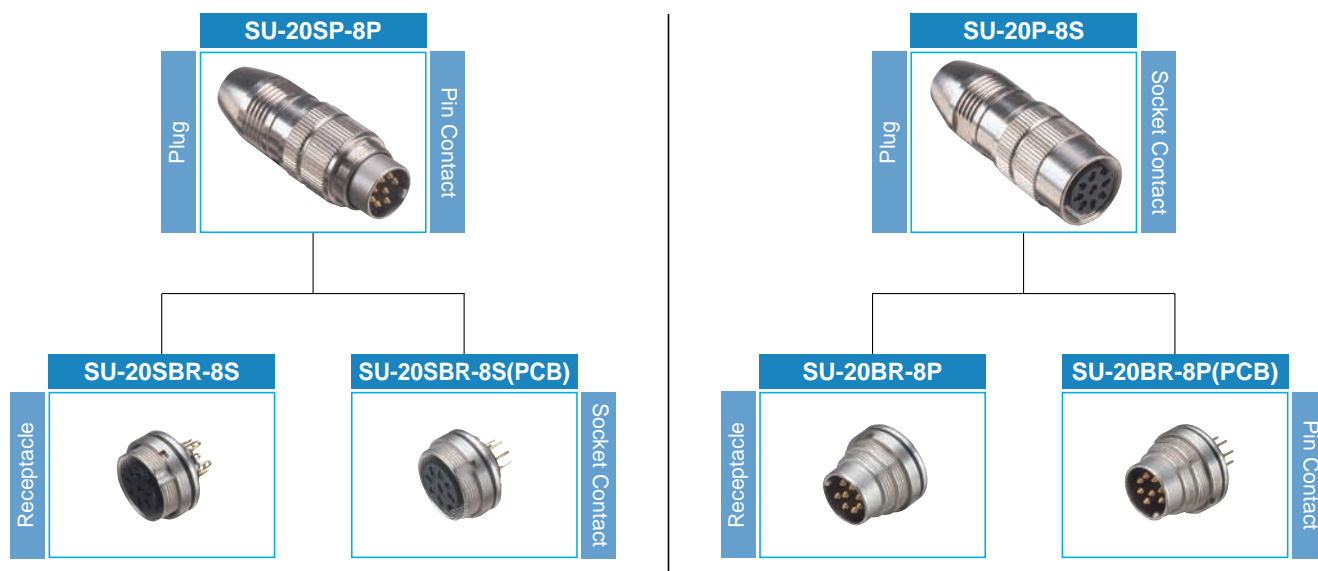

Specifications subject to change without notice. Consult Sam Woo Electronics for the latest specifications.

SU Series – Plug, Receptacle

SU-20SP-8P

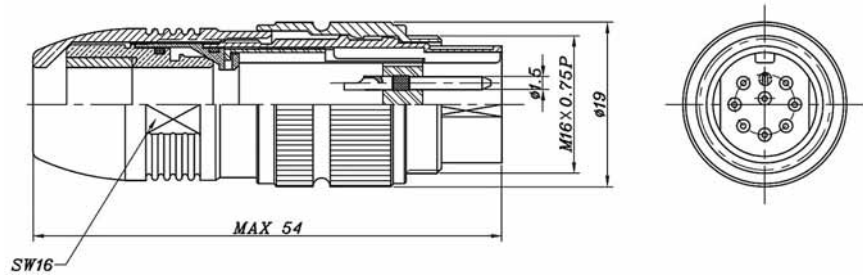

SU-20SBR-8S

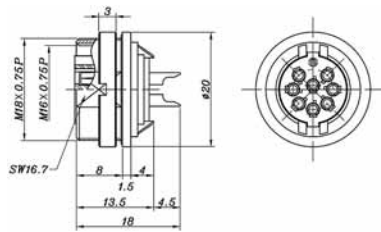

SU-20SBR-8S(PCB)

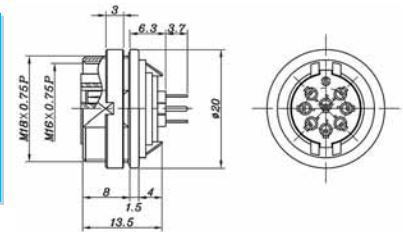

SU-20P-8S

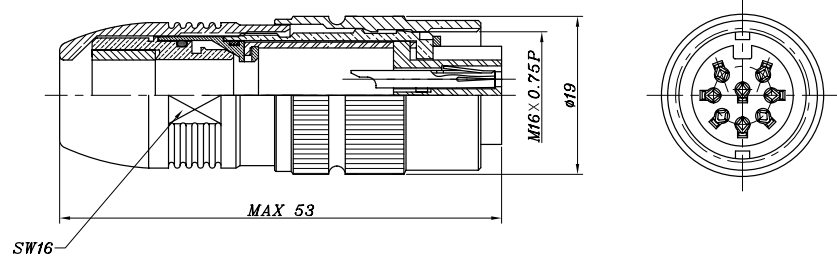

SU-20BR-8P

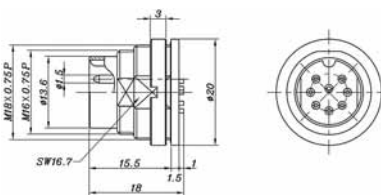

SU-20BR-8P(PCB)

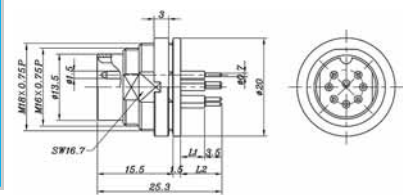

L1 and L2 customizable upon request.

L ₁	L ₂
4.8	8.3

SU Receptacle Panel Layout

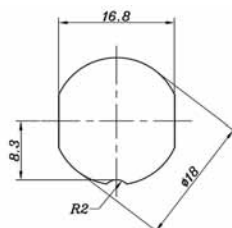

Used for SU-20SBR-8S and SU-20BR-9P

SU Receptacle PCB Layout

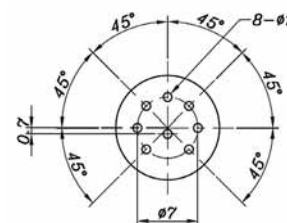

Used for SU-20SBR-8S(PCB) and SU-20BR-9P(PCB)

Specifications subject to change without notice. Consult Sam Woo Electronics for the latest specifications.

Receptacle Cap



SU-20BRC / SU-20SBRC

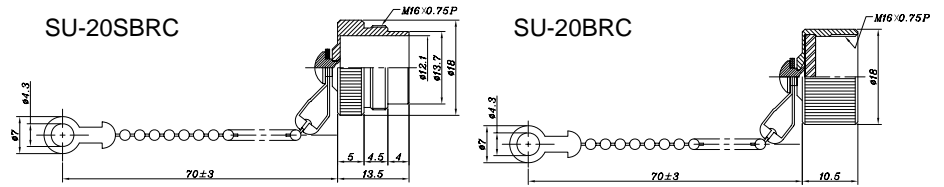

Wrench

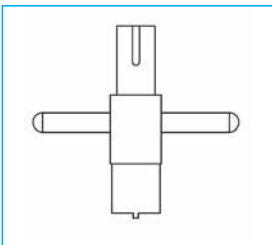

SU-WP



SU-WR

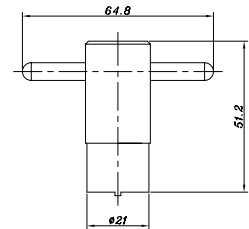
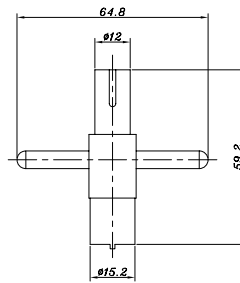

Cable Assembly Instruction

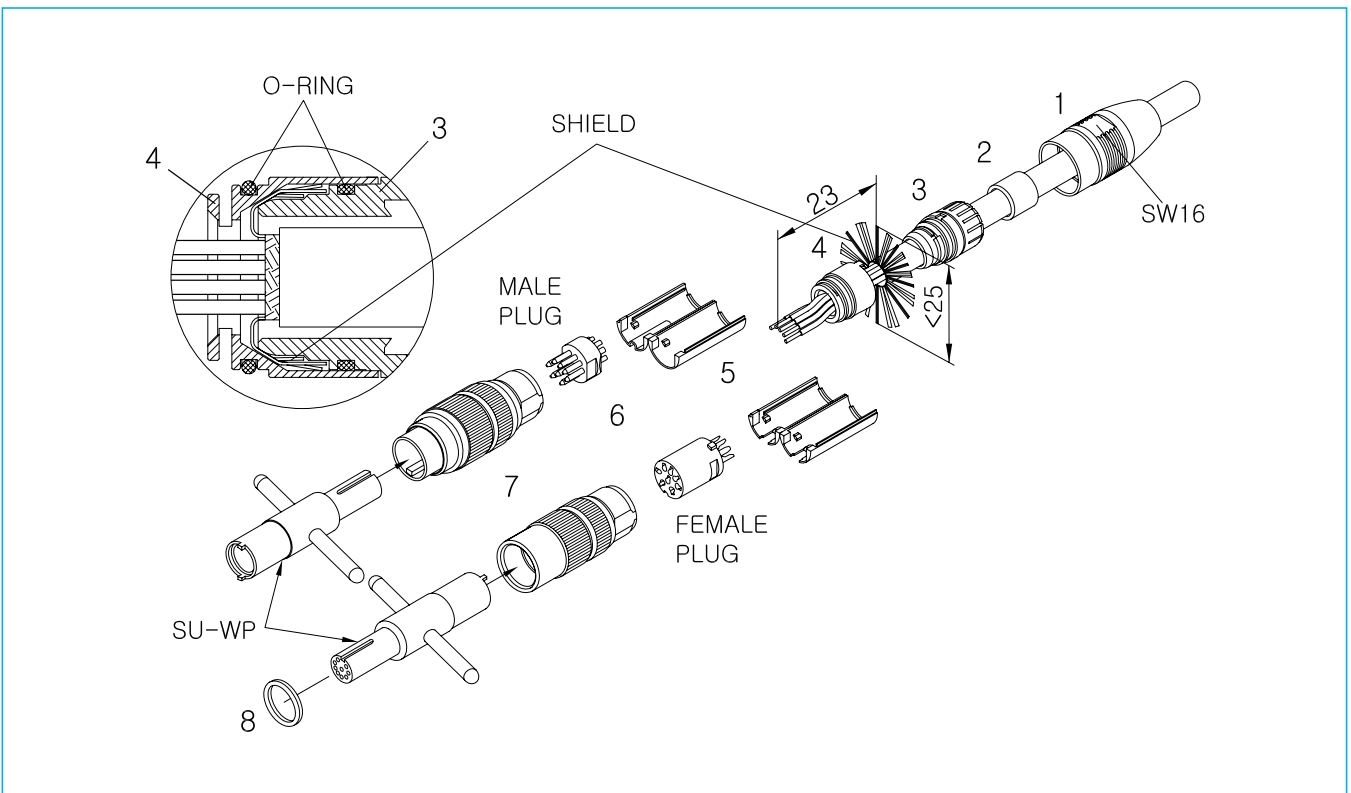

Specifications subject to change without notice. Consult Sam Woo Electronics for the latest specifications.